

DIN 6331

Hexagon nuts

With flange | height = 1,5 d

Stainless steel A2 | Cr(VI)-free | Metric thread

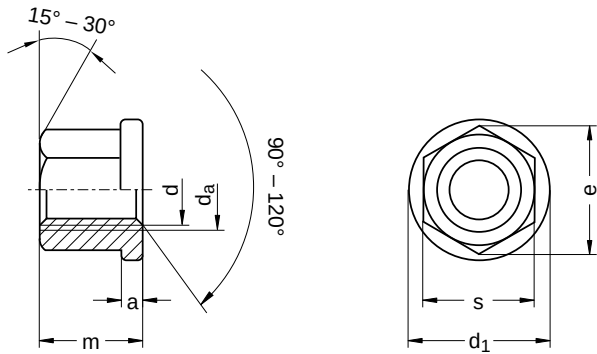

Diameter (d)	a nominal size	d ₁ nominal size	d _a		m nominal size	e min.	s nominal size	Pitch (P)	Tool size
			min.	max.					
M8	3.5	18	8	8.75	12	14.38	13	1.25	SW 13
M10	4.0	22	10	10.80	15	17.77	16	1.50	SW 16
M16	5.0	31	16	17.30	24	26.75	24	2.00	SW 24
M20	6.0	37	20	21.60	30	33.53	30	2.50	SW 30
M24	6.0	45	24	25.90	36	39.98	36	3.00	SW 36
M30	8.0	58	30	32.40	45	51.28	46	3.50	SW 46
M36	10.0	68	36	38.90	54	61.31	55	4.00	SW 55

All technical data refer to the measure mm

